

MATERIAL		YTFINISH		BESKRIVNING Töre 2,6 x 3,8		
RITAD AV		DATUM 2017-02-23	STORLEK A3	PROD. NR.	FILNAMN	REV.
KONTROLLERAD AV		DATUM	SKALA 1:50	FORMGIVARE		BLAD 1 av 7

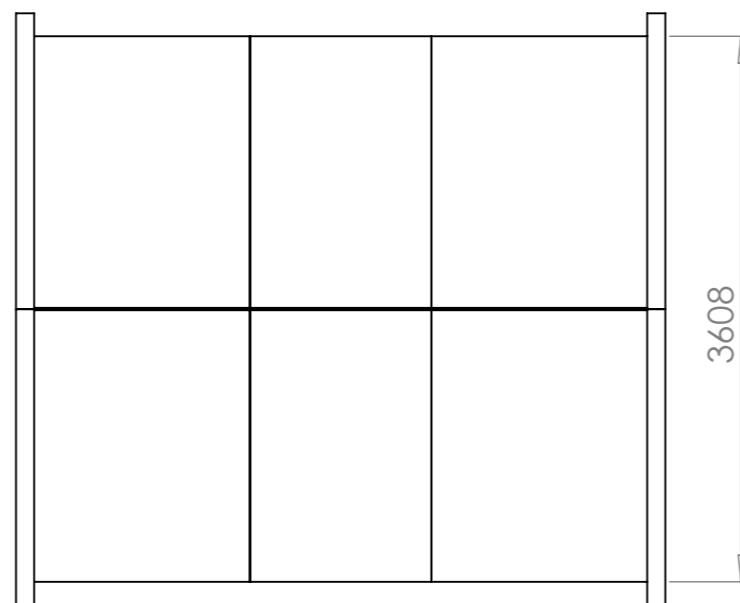
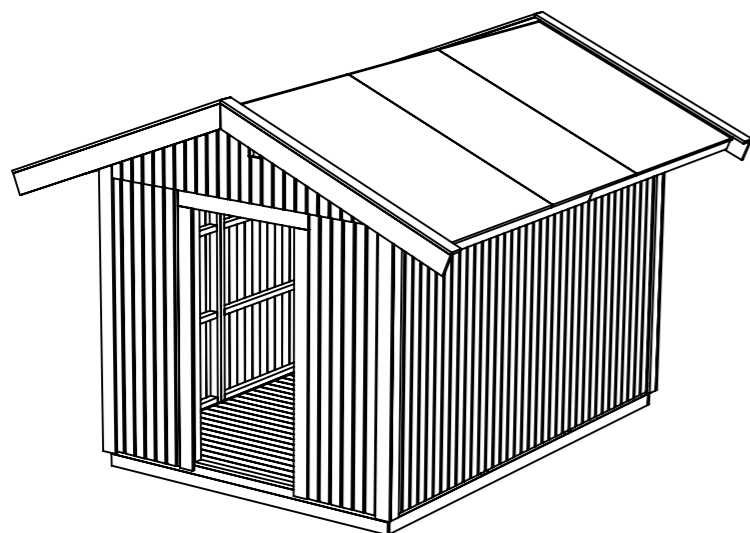
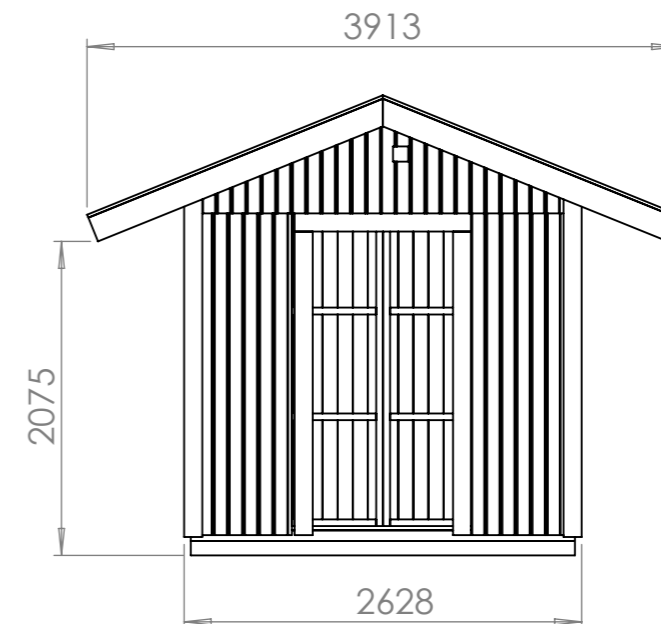
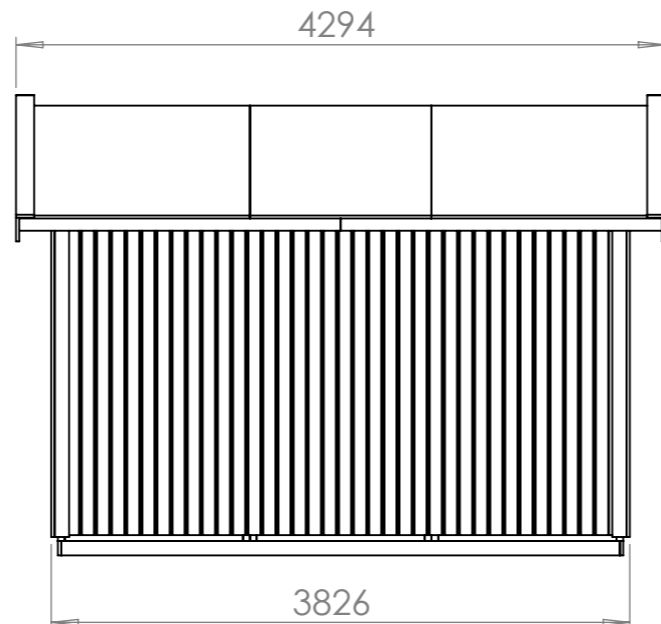
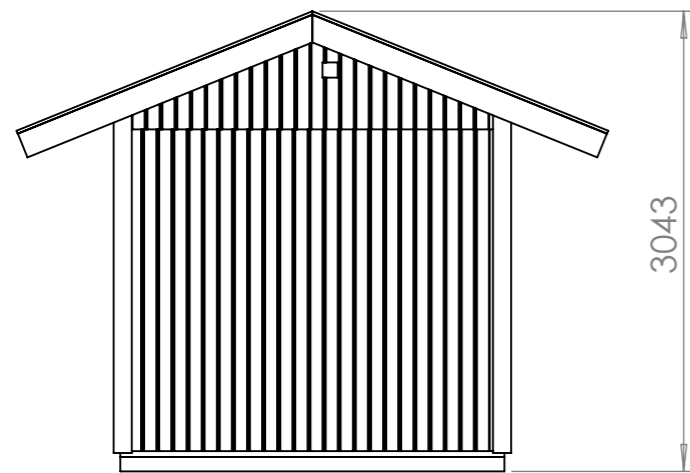

- 1 Töre bärlina 3740mm 3st
- 2 Töre golvblock yttre 2st
- 3 Töre golvblock mitt 1st
- 4 Töre syll och hammarband längd 2540mm 4st
- 5 Töre syll och hammarband längd 3598mm 4st
- 6 Töre väggblock 1200mm 8st
- 7 Töre väggblock 600mm 2st
- 8 Töre hörnstolpe 70x70mm 4st
- 9 Töre takstol gavel 2st
- 10 Töre takstol mitt 2st
- 11 Töre knutbräda gavel 4st
- 12 Töre knutbräda långsida 4st
- 13 Töre blockskarv 16st
- 14 Töre dörrblock för dörr 1st
- 15 Töre Takskivor plywood gavelbitar 4st
- 16 Töre Takskivor plywood mittenbitar bitar 2st
- 17 Töre Hängbrädor 2125 mm 4st
- 18 Töre vindskivor 2,6m 4st
- 19 Töre vattbrädor 2,6m 4st
- 20 Underlagspapp
- 21 Dörrfoder i 3 delar 1 st
- 22 Täckbräda tryck imp för bärlina 2540 mm 2st (22x95)
- 23 Packsats med spik & skruv för montering 1st sats

MATERIAL		YTFINISH		BESKRIVNING		
				Töre 2,6 x 3,8		
RITAD AV	DATUM	STORLEK	PROD. NR.	FILNAMN	REV.	
	2017-02-23	A3				
KONTROLLERAD AV	DATUM	SKALA	FORMGIVARE	BLAD		
		1:50		2 av 7		

1. Lägg ut bärlinorna på plan mark enligt nedan

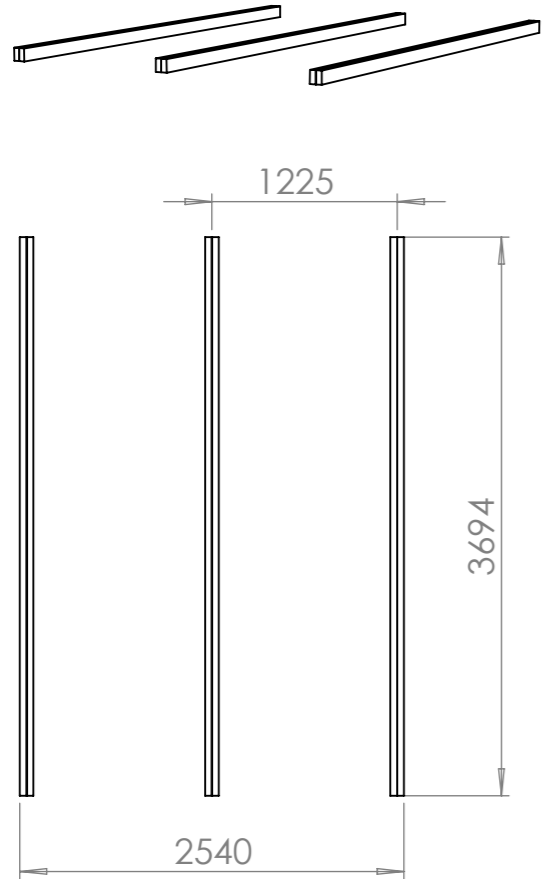

2. montera golvblocken och täckbrädorna

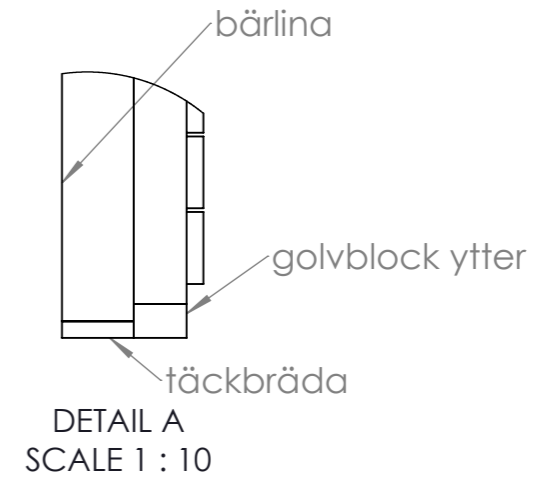
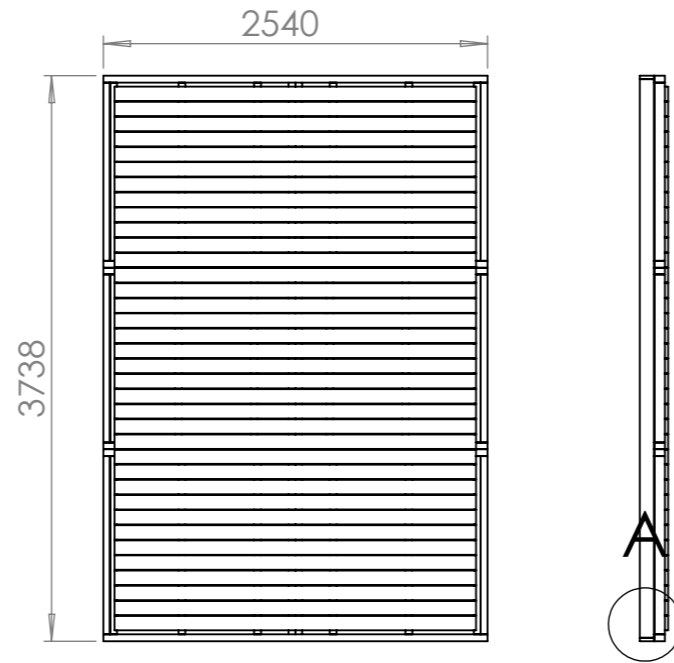
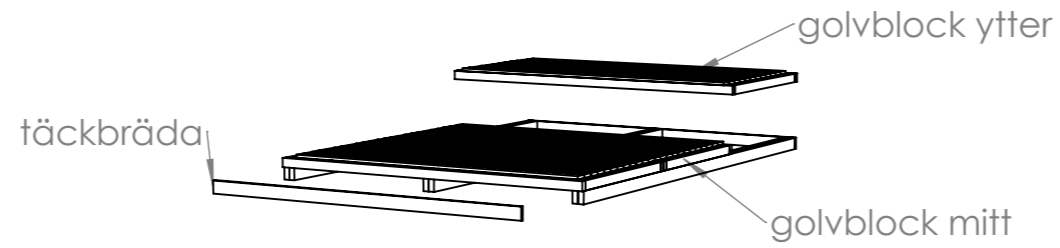

3. Spika syllen mot golvblocken

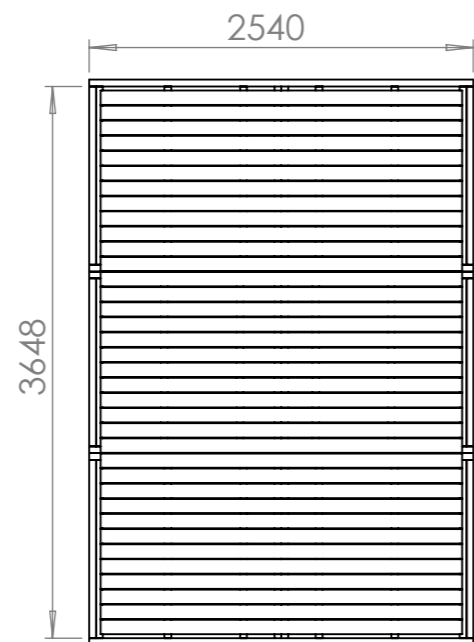

MATERIAL		YTFINISH		BESKRIVNING		
				Töre 2,6 x 3,8		
RITAD AV		DATUM	STORLEK	PROD. NR.	FILNAMN	REV.
		2017-02-23	A3			
KONTROLLERAD AV		DATUM	SKALA	FORMGIVARE		BLAD
			1:50			3 av 7

3. Montera väggblocken

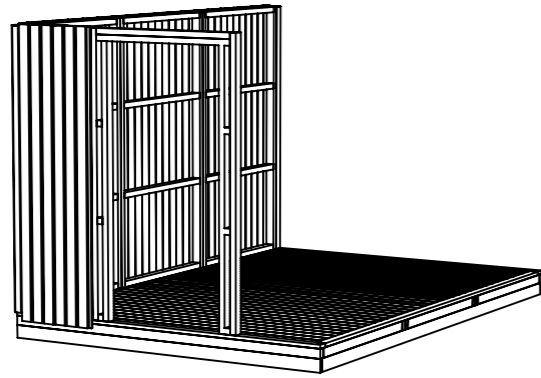

4. Spika hammarbanden ovanpå väggarna.

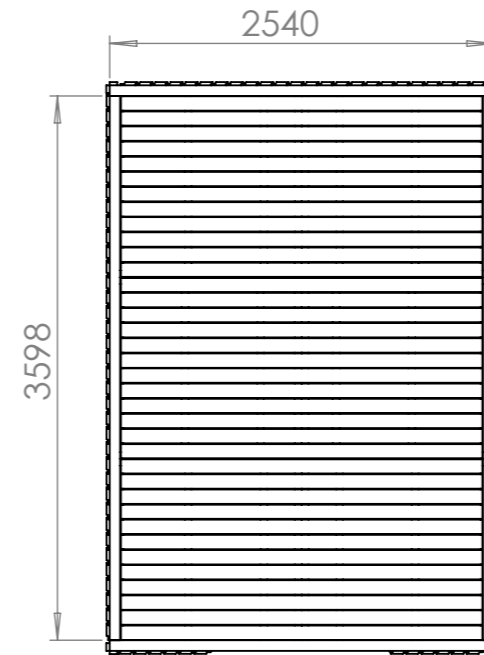
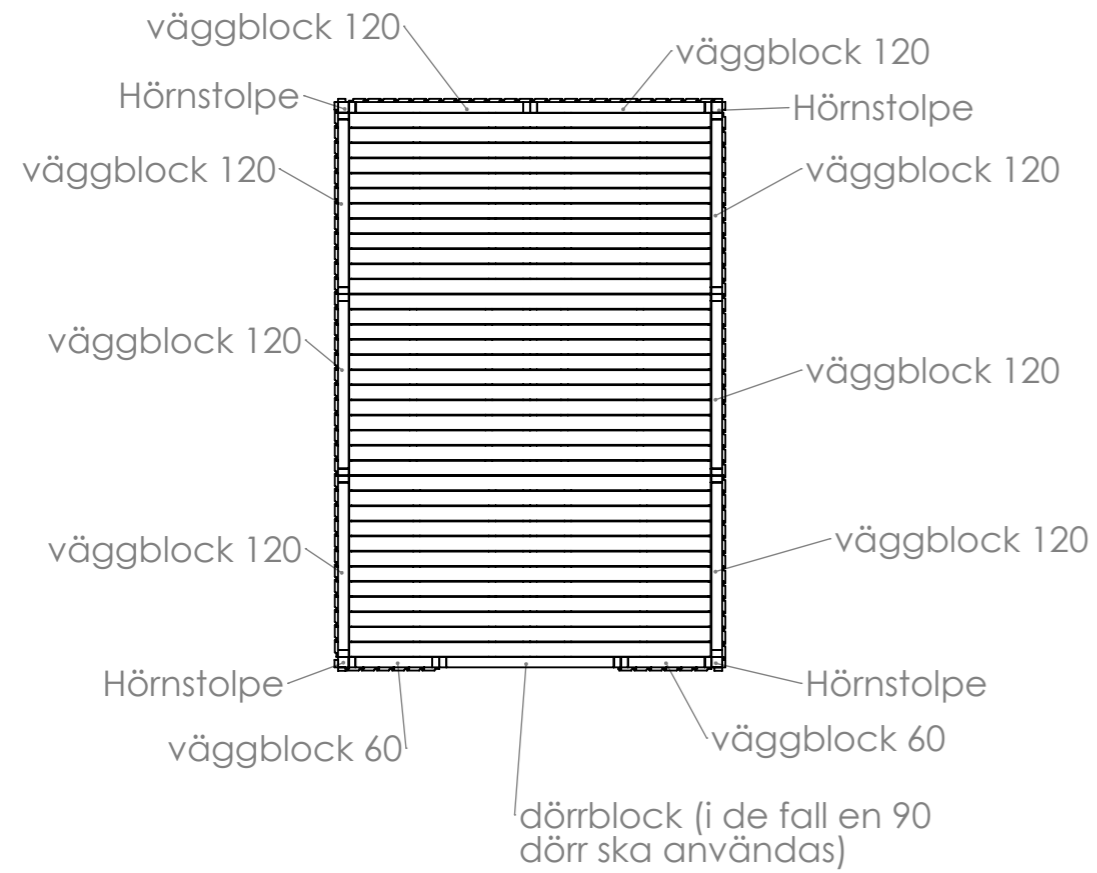
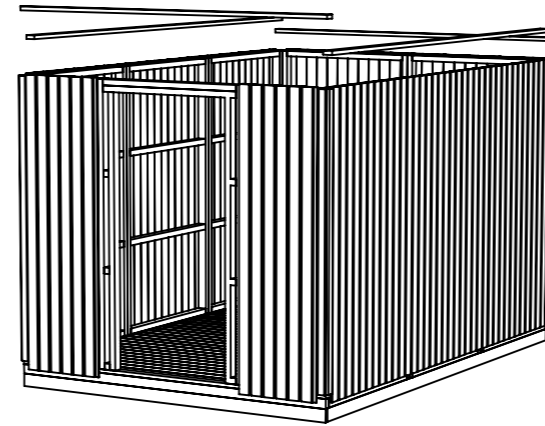

MATERIAL		YTFINISH		BESKRIVNING		
				Töre 2,6 x 3,8		
RITAD AV		DATUM	STORLEK	PROD. NR.	FILNAMN	REV.
		2017-02-23	A3			
KONTROLLERAD AV		DATUM	SKALA	FORMGIVARE		BLAD
			1:50			4 av 7

5. montera takstolar

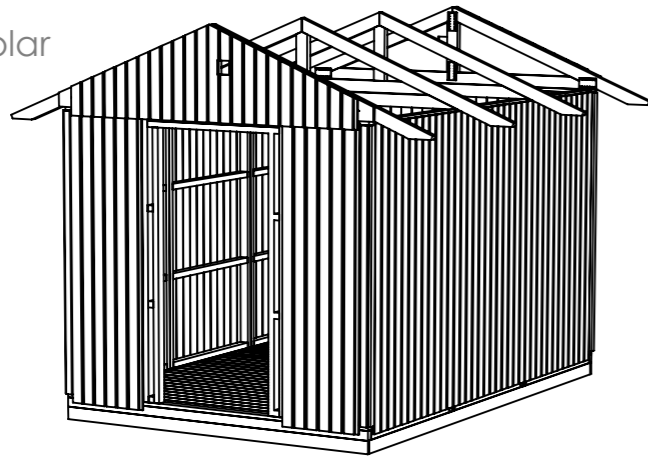

6. montera knutbrädorna

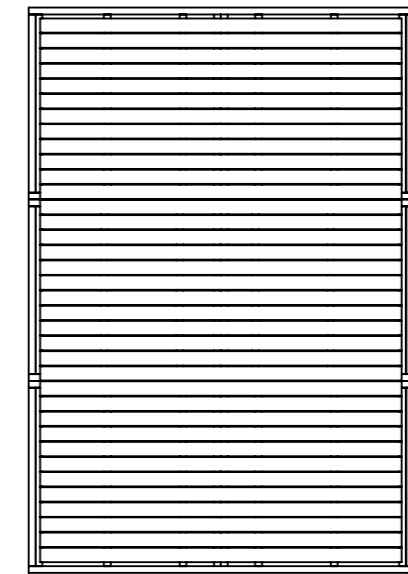
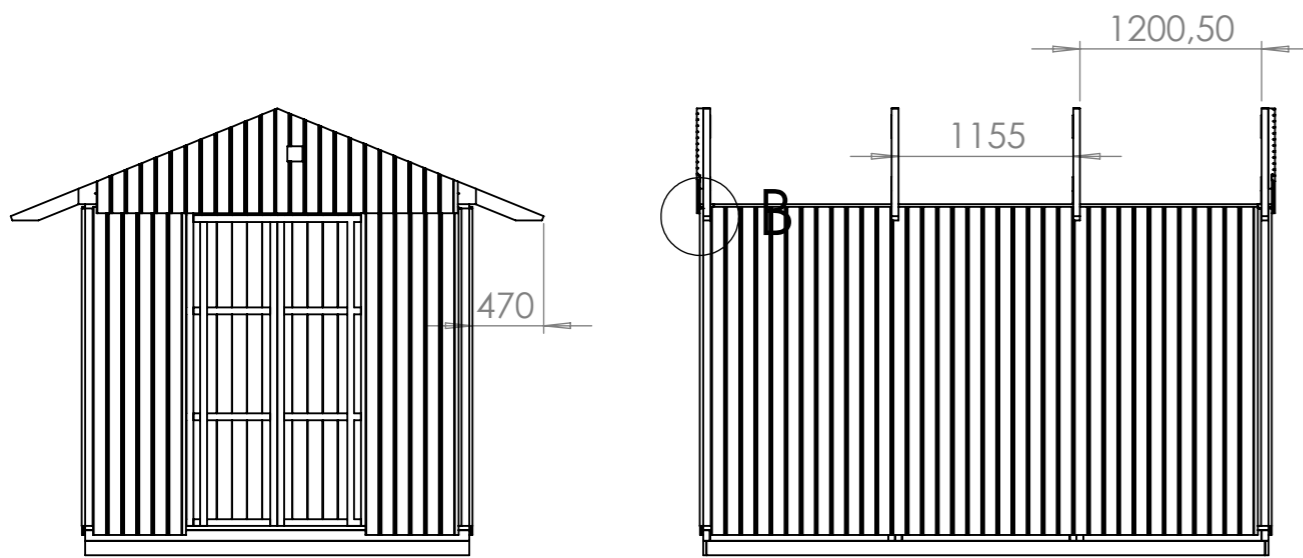
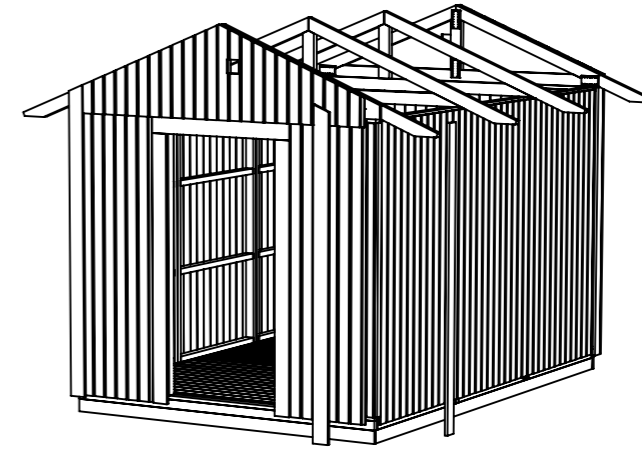

Knutbrädor

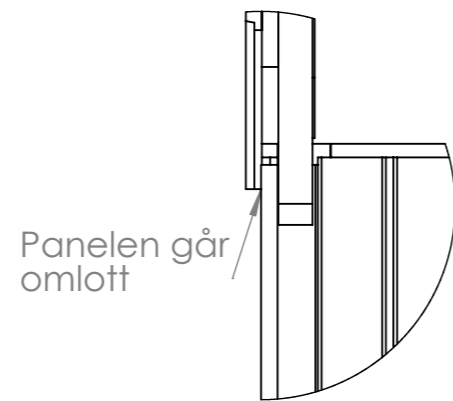
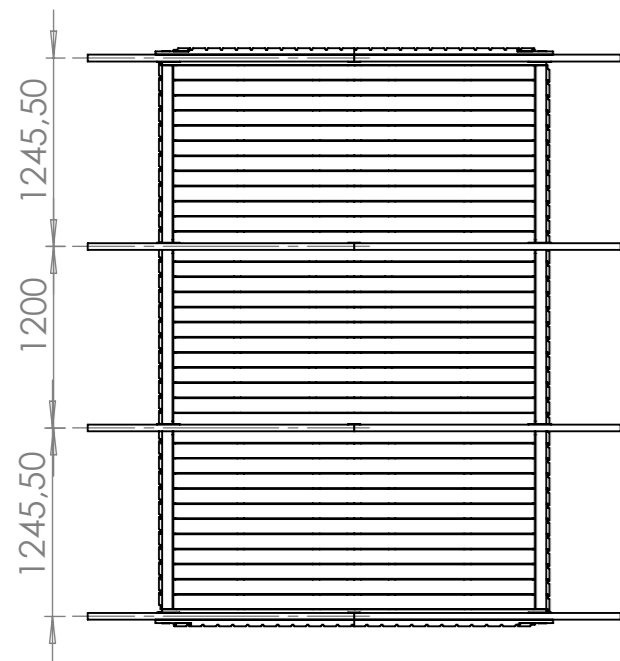

Panelen går omlott

DETAIL B  
SCALE 1 : 10

MATERIAL		YTFINISH		BESKRIVNING		
				Töre 2,6 x 3,8		
RITAD AV		DATUM	STORLEK	PROD. NR.	FILNAMN	REV.
		2017-02-23	A3			
KONTROLLERAD AV		DATUM	SKALA	FORMGIVARE		BLAD
			1:50			5 av 7

7. montera brädorna mellan takstolarna

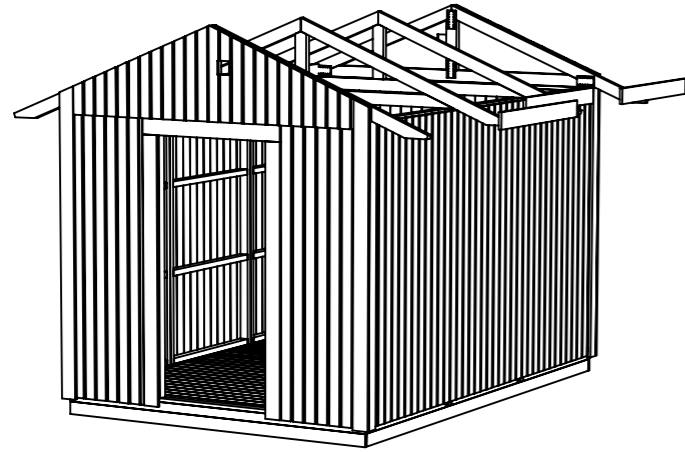

8. Montera takskivorna

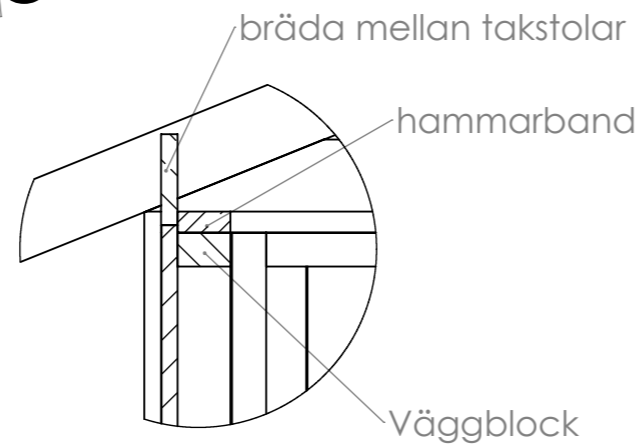
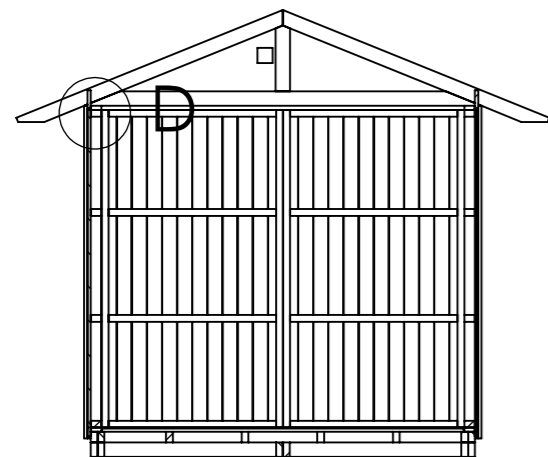
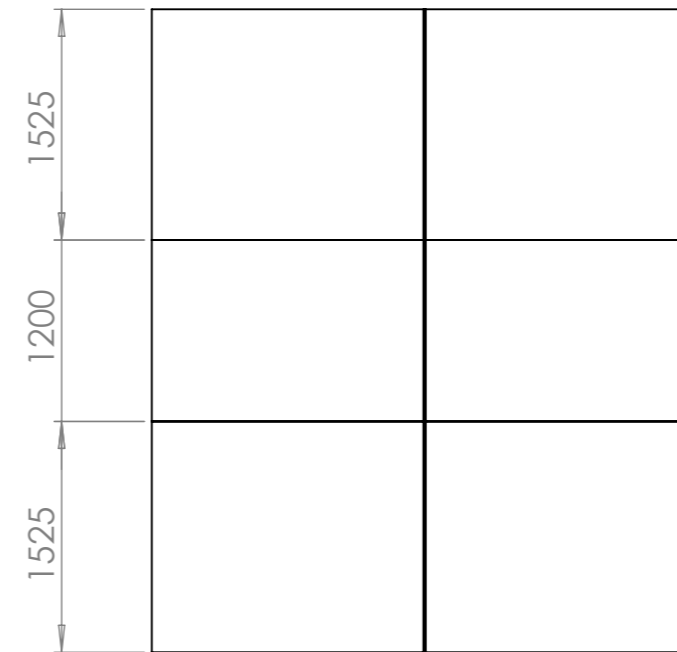
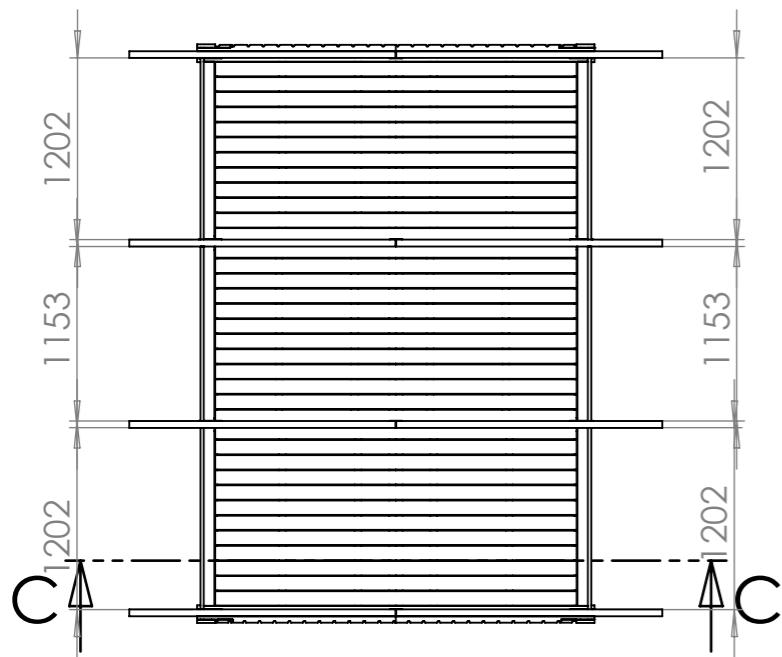
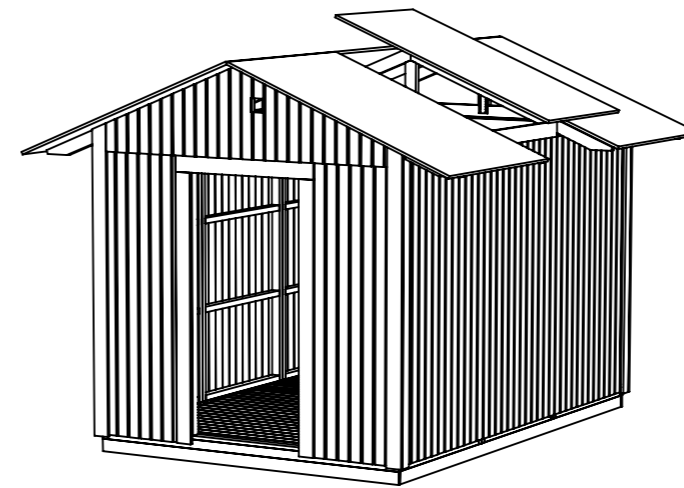

DETAIL D  
SCALE 1 : 10

SECTION C-C

MATERIAL		YTFINISH		BESKRIVNING		
				Töre 2,6 x 3,8		
RITAD AV		DATUM	STORLEK	PROD. NR.	FILNAMN	REV.
		2017-02-23	A3			
KONTROLLERAD AV		DATUM	SKALA	FORMGIVARE		BLAD
			1:50			6 av 7

9. Montera hängbrädorna

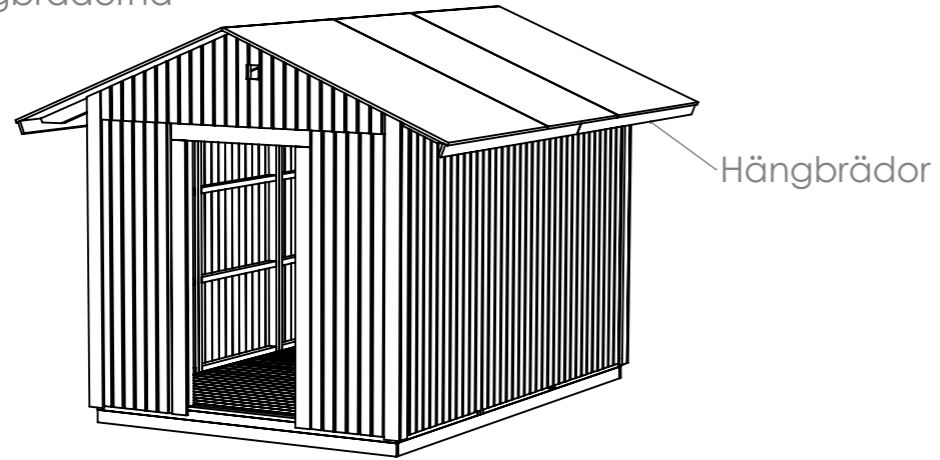

10. Montera vindskivor, vattbrädor och 3-kantslist

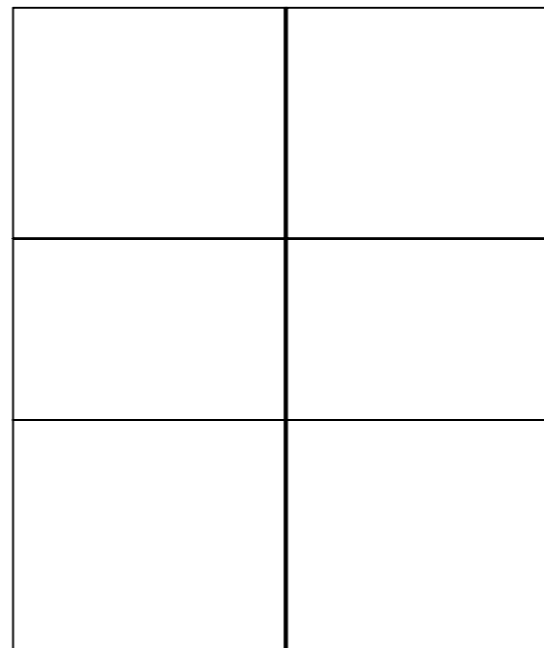
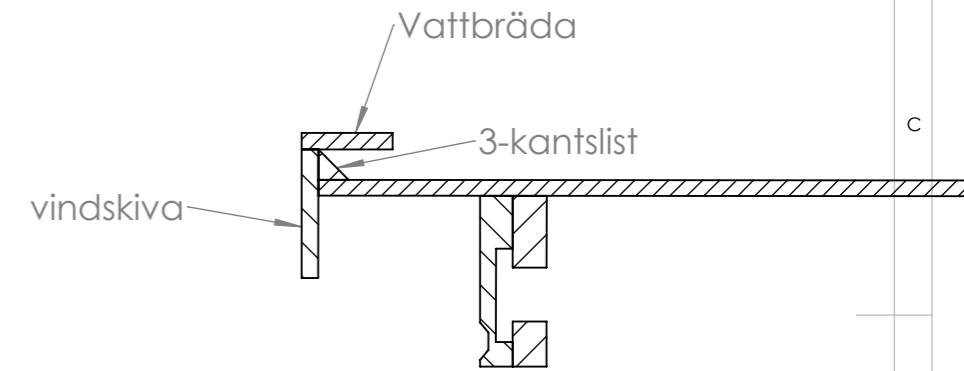
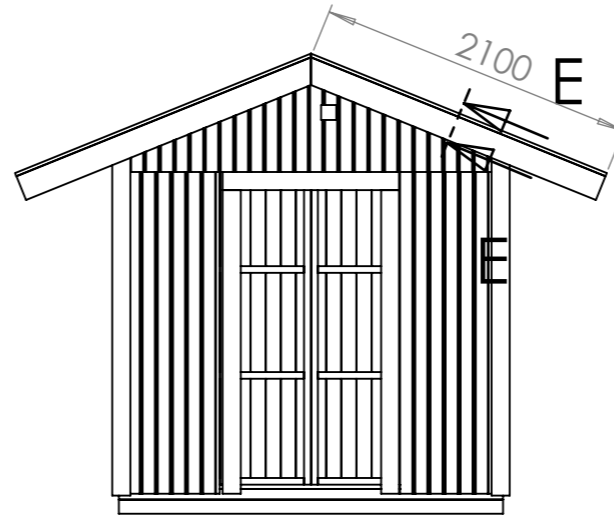
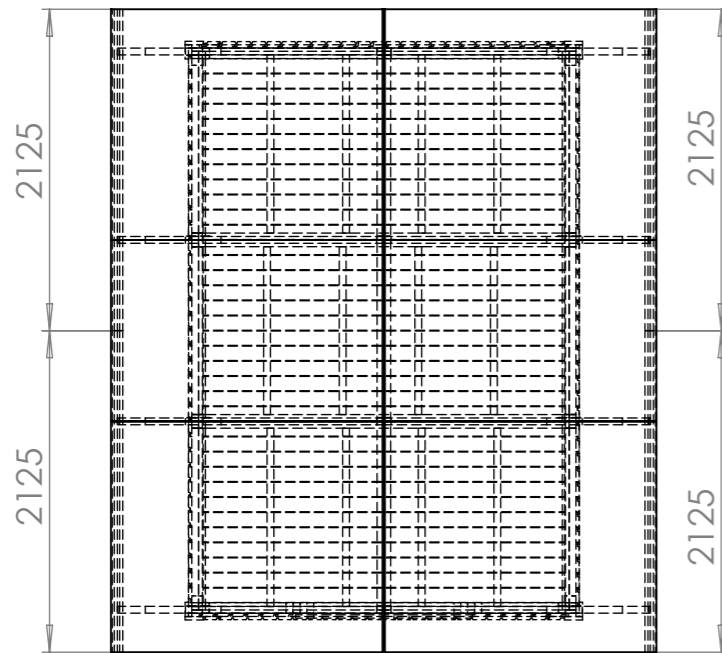
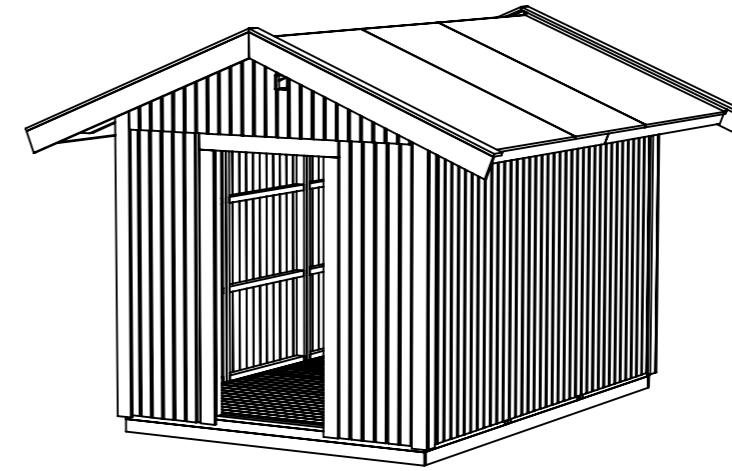

BESKRIVNING

Töre 2,6 x 3,8

MATERIAL	YTFINISH				
RITAD AV	DATUM 2017-02-23	STORLEK A3	PROD. NR.	FILNAMN	REV.
KONTROLLERAD AV	DATUM	SKALA 1:50	FORMGIVARE	BLAD 7 av 7	