

The image features a collection of abstract, stylized shapes in dark green and bright red against a light gray background. The shapes include a large curved green shape at the top left, a red shape resembling a stylized arch or bridge at the top right, a bundle of five red parallel lines in the center, a green stepped shape on the left, a green rounded trapezoid at the bottom center, a green arch-like shape with vertical lines on the right, a red tree-like shape at the bottom left, and a large wavy green shape at the bottom. The word "nola" is written in a white, lowercase, sans-serif font, centered horizontally and partially overlaid by the red bundle of lines. A small registered trademark symbol (®) is located to the right of the letter 'a'.

nola[®]



nola[®]

© 2021 Nola Industrier AB

*Nola Stockholm: +46(0)8–702 19 60
Repslagargatan 15B
Box 17701 118 93 Stockholm, Sweden*

*Nola Malmö: +46(0)40–17 11 90
Skeppsbron 3 211 20 Malmö, Sweden*

*Photo: Jann Lipka (p. 2–27, 32–33, 40, 45,
47, 56–59), Studio E (p. 28–31), Daniel
Engvall (p. 61), Kauppi & Kauppi (p.65)
Design & production: Nuet
Printing: Taberg Media Group, Bromma, Sweden
Paper: Arctic Munken Polar*

nola.se

4

Projects

*Torsgatan, Stockholm
Fornudden School, Tyresö
Östra Drottninggatan, Gävle
Långbordet, Stockholm & Helsingborg*

4

5

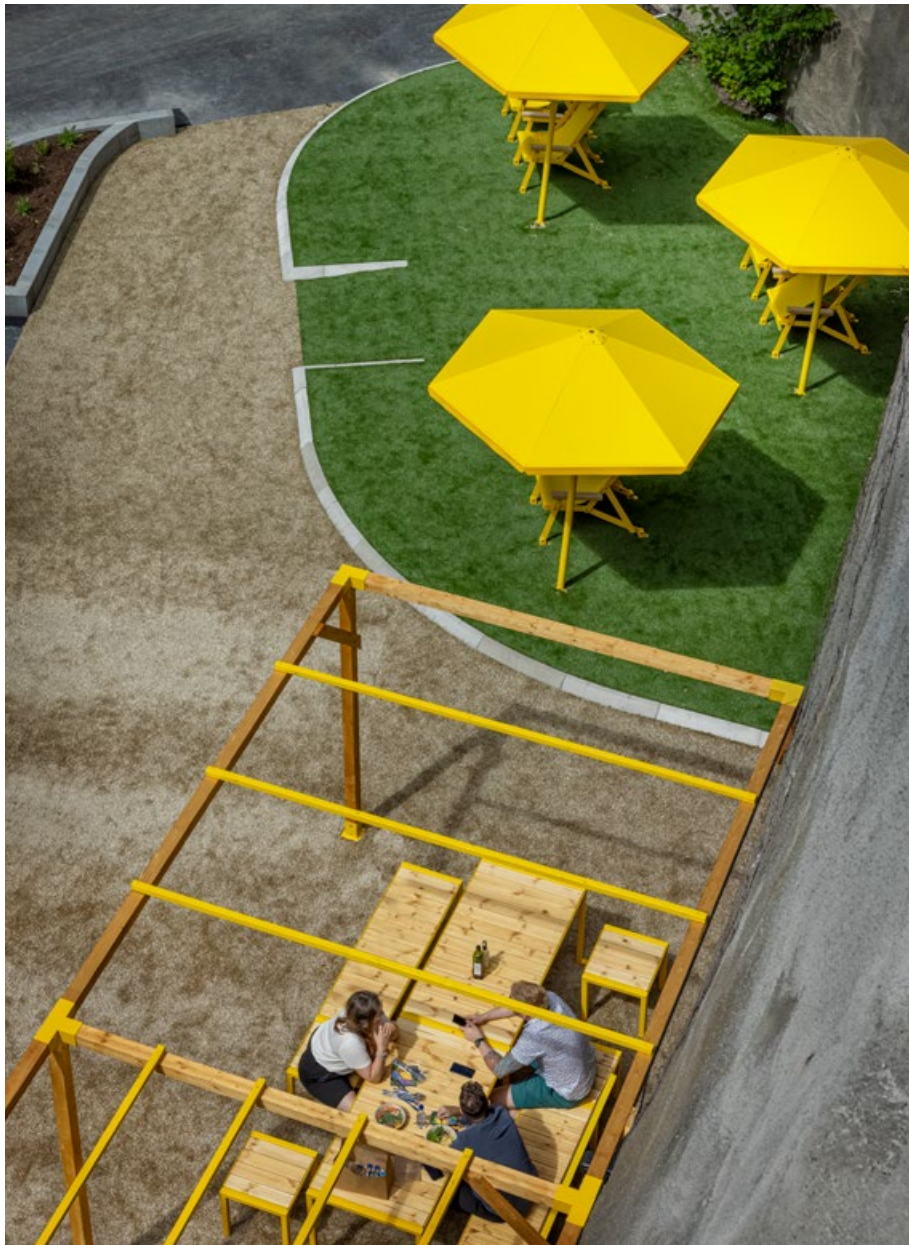

Commissioner: Castellum
 Landscape Architects: Groot Utemiljöer
 Completion: 2021



Torsgatan, Stockholm

Located on Stockholm's Torsgatan, a courtyard situated behind the landmark Stockholm Vatten building has been redesigned with recreation, activity and socialising in mind. Landscape architects Groot Utemiljöer created a setting inspired by an urban beach theme, placing sun loungers and sun parasols on a private — but inviting — lawn in the midst of the city's concrete and stone. Dating back to 1906, today the courtyard is an active space for year-round use, accessible to those living and working in adjacent buildings.

Nola's Loj sun chair, Four Seasons sun parasol and Långbordet modular community seating were included in the project.

Left:
 Loj sun chair and Four Seasons parasol in yellow, designed by Thomas Bernstrand. Långbordet, designed by White Arkitekter, is placed beneath a pergola.

Next spread:
 With a padel court next to the chairs and benches the courtyard is both a place for activation and relaxation.

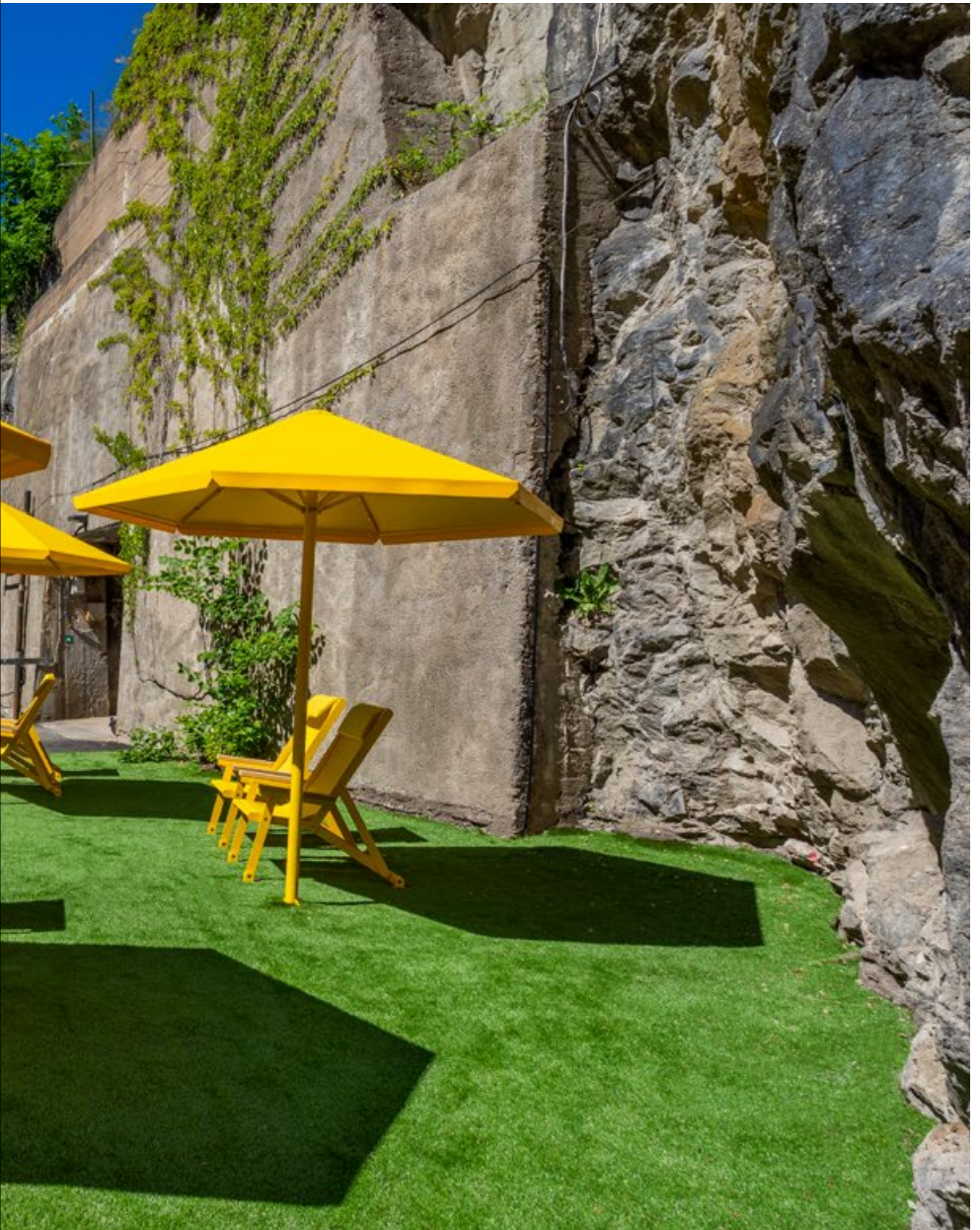
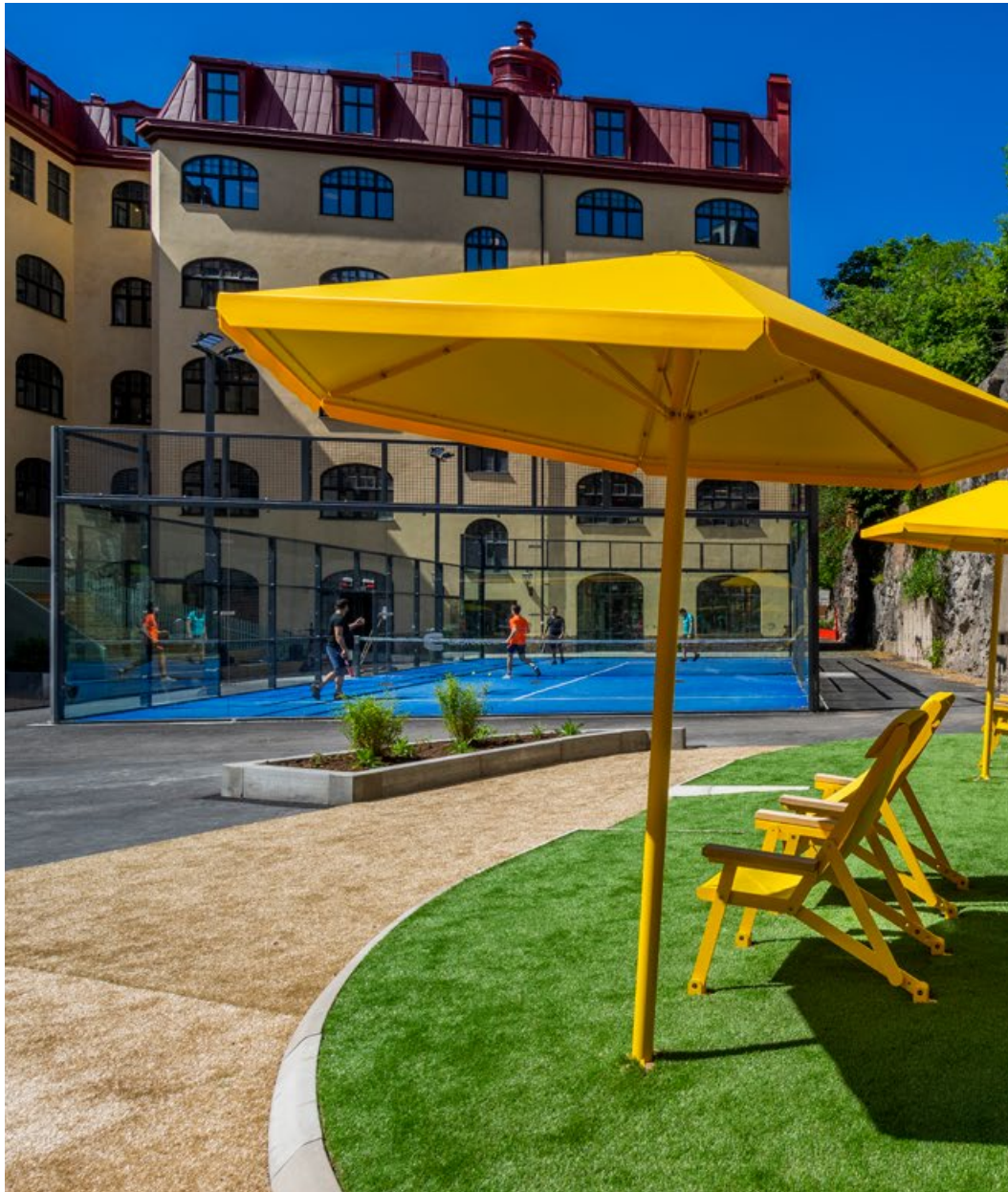

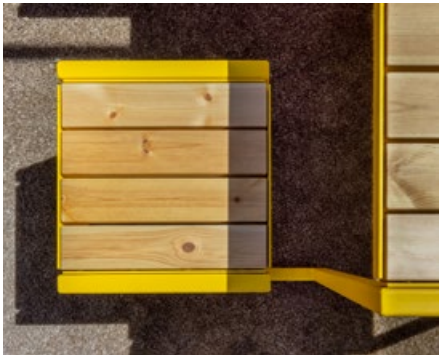

Above:
Långbordet is a flexible and modular system with integrated parts, perfect for public spaces or court yards. Here modified with a back rest.

Right:
Loj sun chair, designed by Thomas Bernstrand, won Best Outdoor Furniture at Elle Decoration Awards 2019. Here seen with Four Seasons all year parasol.

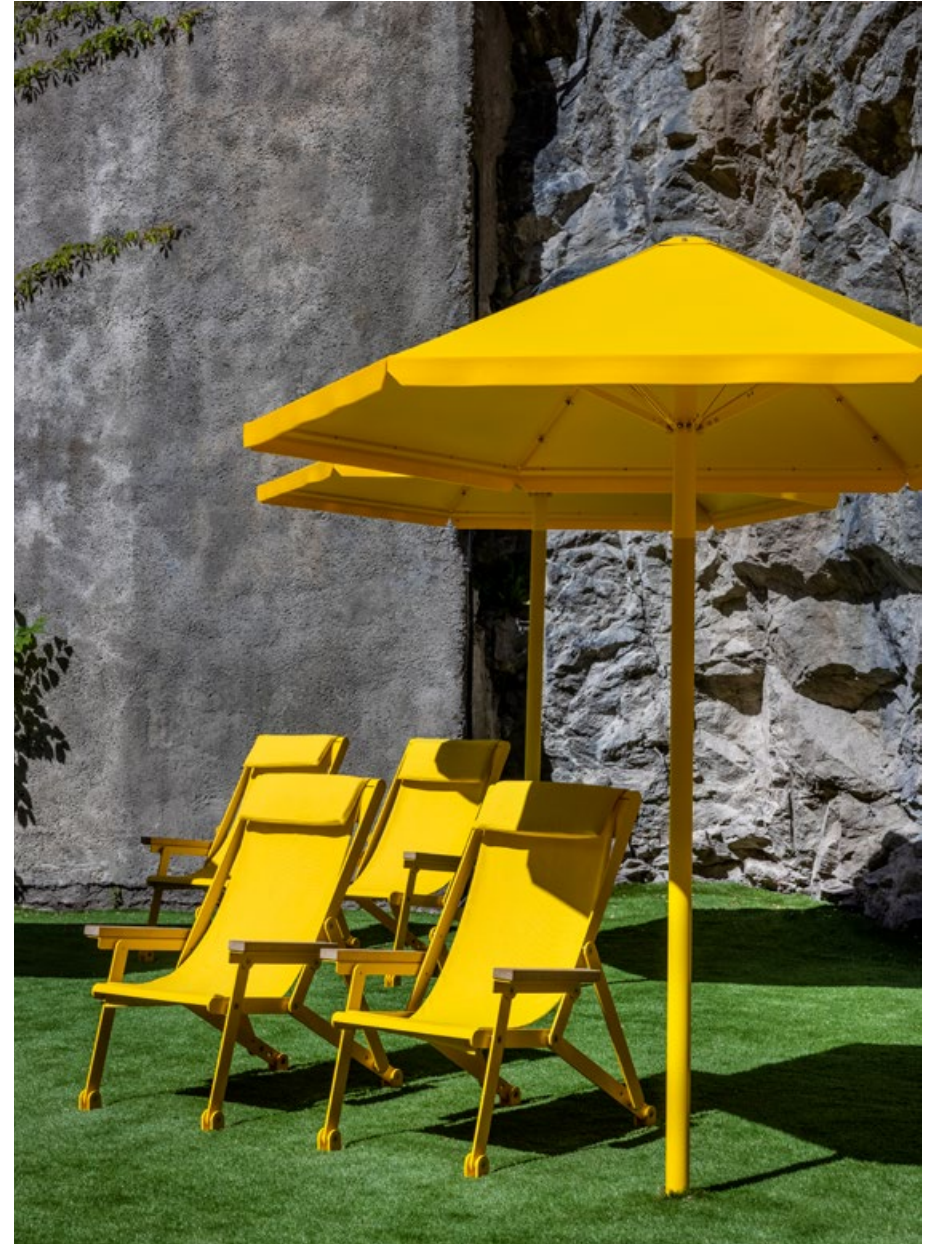



Commissioner: Tyresö Municipality
 Landscape architects: Tengbom
 Date completed: 2021



Fornudden School, Tyresö

Greater Stockholm's Tyresö municipality is growing and in 2018 the need for a new school became clear. Three years later, a new school was built by NCC Construction with capacity for 750 students in grades ranging from pre-school to year nine. A large schoolyard was developed around the building to make spaces for play, movement and exercise.

Nola provided chairs, benches and tables from Broberg & Ridderstråle's Parco series for installation throughout the outdoor areas.

Left:
 Parco park benches and tables in Jatoba wood were installed throughout the outdoor areas. Their metal frames were powder-coated in a variety of colours.

Above:
 From beneath the Parco park benches and tables, graphic paving patterns spread carpet-like motifs over the site. The outdoor running track provides an arena for exercise and play.

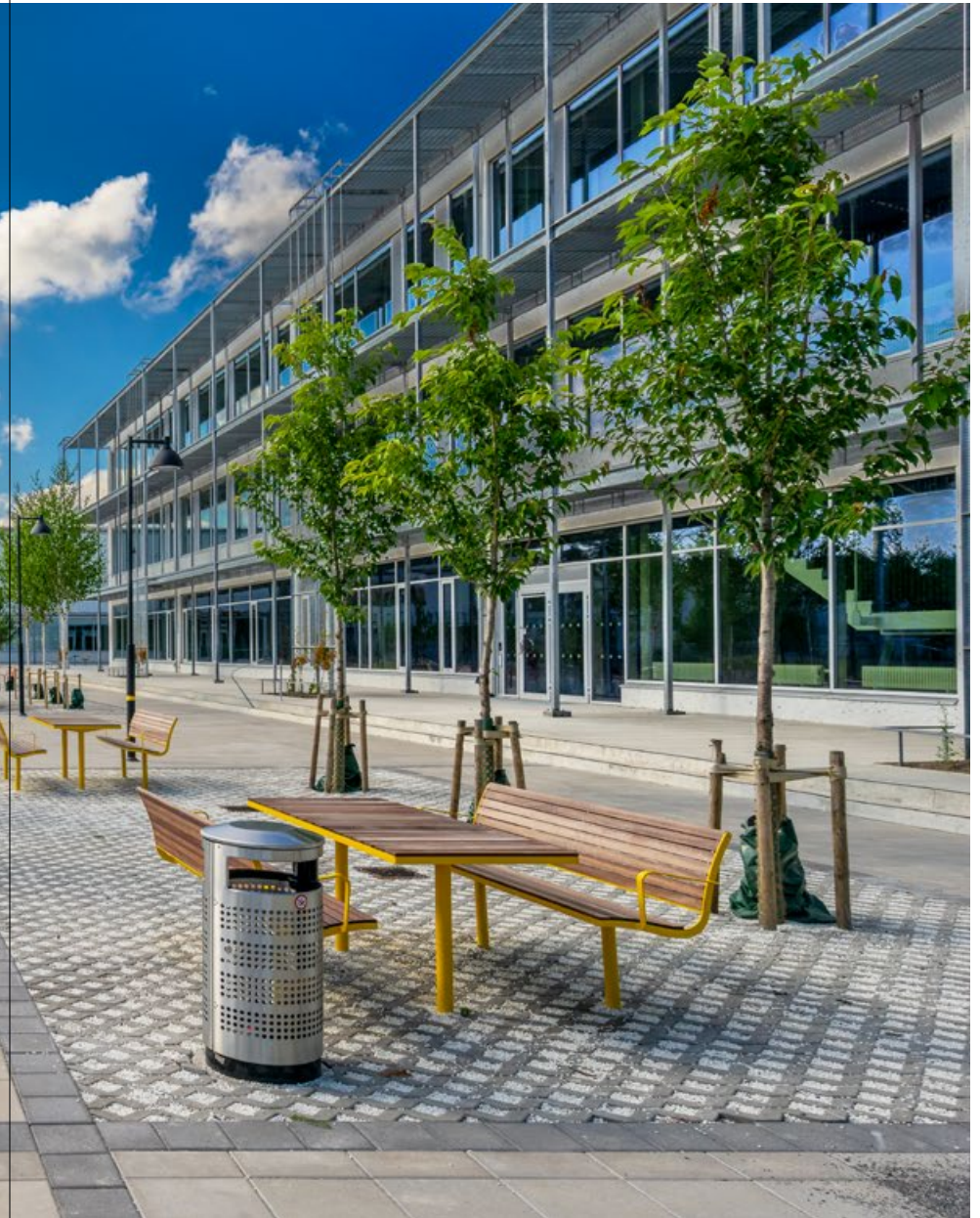

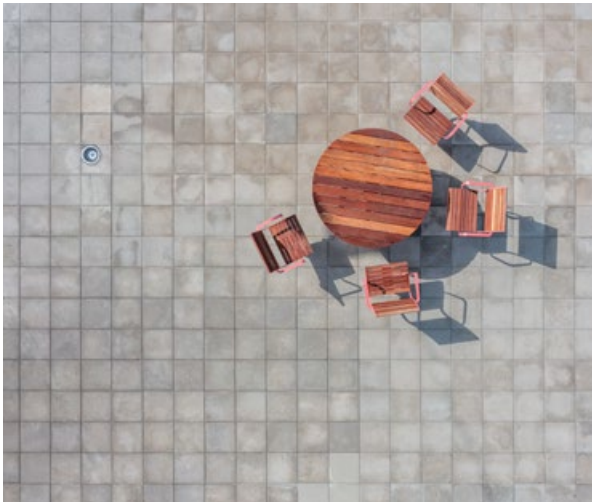

Above:
Nola's Akalla pergola in powder-coated steel and oak was installed in the outdoor area.

Left:
Powder-coated in pastel pink, Parco swivel chairs and tables present a colourful contrast to the grey paving beneath them.

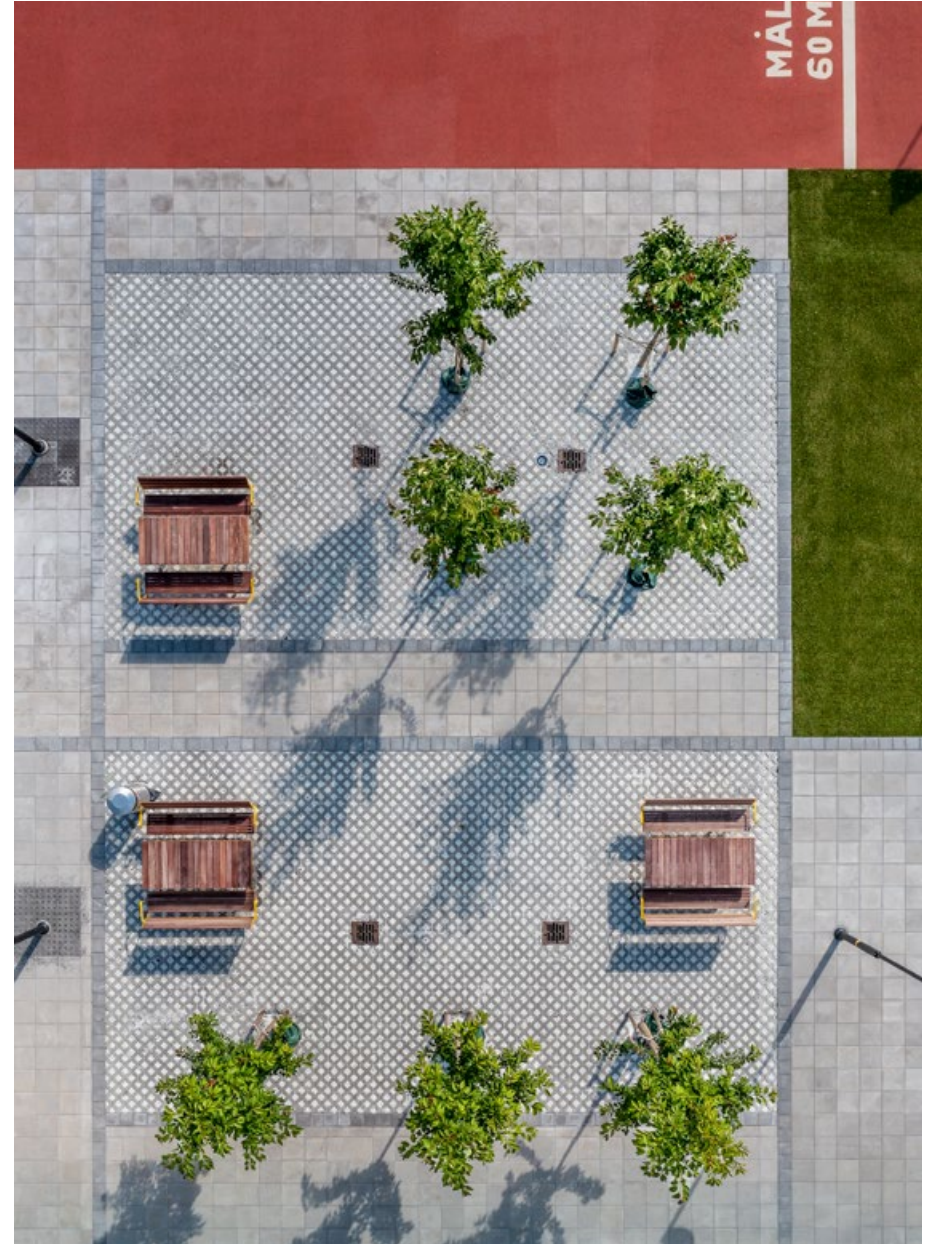



Commissioner: Gävle municipality
Landscape architects: Karavan
Completion: 2020



Östra Drottninggatan, Gävle

Renovation and design of the Östra Drottninggatan pedestrian street in central Gävle, Sweden, designed by the landscape architecture firm Karavan. Built at different times and in a range of styles, there is a lot of variety in the surrounding architecture. Karavan have tied the environment together using a specially-designed, carpet-like pattern to guide pedestrians between shops, seating areas and green zones. Outdoor armchairs, individual seats, park benches and tables by Nola have been used throughout the site. Placed in small clusters along the street, they demarcate individual areas for socialising and relaxation.

*This spread:
Frank armchair designed by David Taylor. In this project Karavan combined Frank with tables and child seats from our Parco furniture range, designed by Broberg & Ridderstråle.*





*Upper left:
Just as the name suggests, the Frank furniture group makes a straightforward statement. The chair and park bench are accessible and inclusive, offering higher seats and longer armrests to provide support for those less able. The child's chair offers rest for shorter legs.*

*Lower left:
Crafted in 100% recyclable sand-cast aluminium, Frank combines sustainability and style.*





Långhuset

Hamntorget, Stockholm
Furutorpsplatsen, Helsingborg

“Conversations along the table are casual, but intense. At one end, snickering teenagers talk about things they got away with, then laugh raucously for all to hear. A few seats away, schoolboys complain about a sports coach no one likes, and quickly hunker down when he suddenly appears and walks past. Further along the table, a group of locals are hanging out together, sitting far apart as they maintain social distancing. One of them glances towards the other end of the table, where children can be heard. It sounds like the grown-ups are throwing a party for them, but it’s hard to see that far. Like everyone else, they’re probably wondering how this long table actually got here, because it seems to meander for miles across the park.”

Sentiments like these were scripted by Swedish architectural practice *White Arkitekter*, and submitted with their entry in a landscaping competition in Helsingborg. Situated on Sweden’s southwestern coastline, the city announced a call for projects that would transform a forgotten area into a meaningful place. Called *Furutorpsplatsen*, the site presented big challenges for the city, and for local residents too. “Issues such as exclusion and segregation, which are some of today’s biggest challenges in urban development, had to be overcome,” explains Taiga Koponen from *White Arkitekter*, an architect who worked on the project.

“The *Långbordet* project was completed quickly, putting everything in place in less than six months,” says Taiga. “The goal was to redesign a public place and make it safer for the residents by installing a temporary meeting place. As far as I know, *Långbordet* is still there, which is gratifying.”

Långbordet is now one of Nola’s most popular products, and its history began in this

site-specific project in Helsingborg. *White Arkitekter* worked collaboratively with artist *Ebba Matz* to develop the concept. After they carried out interviews with locals, the inspiration for a long table was born.

“We got the idea for a long table because we wanted to create a design that all people can relate to, something with a familiar symbolic value, but with different functions,” says Taiga. “Because creating spaces for spontaneous meetings was a priority, a long table felt like the right concept.”

White Arkitekter contacted Nola, who didn’t hesitate to come on board. As a partner in the project, Nola played a key role in realising the design and artistic visions for the site, as well as manufacturing, delivering and installing the tables and seating.



“When we develop new products for public spaces, we think about how to increase the attractiveness of the environment,” explains Agneta Stake, founder and design chief at Nola. “We then consider the needs of each individual place, because they can vary greatly. For example, residential areas, public parks and urban streets have different needs. You have to identify the activities people intend to hold at the site and factor that into the equation as well.”

The table’s distinctive, winding ‘S’ shape was developed in collaboration with committed locals, who voiced their opinions at workshops *White Arkitekter* held near the site. Designing the table to interact with the space itself, and to reflect the area around it, were high on the agenda. That’s where the idea for an S-shaped table was born. Partly because the table’s shape meanders, and partly because

‘S’ stands for ‘south’. Residents identify strongly with living in the southern part of the city, and are proud of how the table literally stamps a big ‘S’ on the local map.

Residents also benefit from the proximity of nature, as plants, shrubs and trees grow around the table. “The table winds in-between the cherry trees growing on the site,” says Taiga,

Left: The table winds between the cherry trees and provides space for conversations and spontaneous meetings between locals.

Above: Furutorpsplatsen in Helsingborg had previously been considered to be dangerous after dark. Långbordet was installed to combat social issues such as exclusion and segregation, make the area safer and make residents happier.



“which means that you can actually sit underneath trees when you take a seat at the table.”

The table’s potential to create unexpected encounters between people who sat at it had to work. The table also needed to make room for activities ranging from picnics, parties and flea markets, to individuals taking a break, or working or studying. Accessibility and functionality were high priorities for both White Arkitekter and Nola, to ensure that the table and seating could accommodate prams, wheelchairs and walkers. To make room for people of all ages and abilities to take a seat and participate in activities, openings were created in the long benches that flank both sides of the table.

Although the table’s design features make it overwhelmingly inclusive, the architects still

wondered if design would be enough to combat the exclusion and segregation that urban planners set out to eliminate. “When we work with similar challenges in urban development projects, we look first and foremost at the broader perspectives,” explains Taiga. “And of course, sustainability from all aspects, not least socially as in this case. It’s a lot about finding features that activate locations and attract people throughout the day. People’s lives and activities can make areas safer, and with attractive designs, we can make them feel comfortable for a long time.”

“What helped to address the social issues at this site was the architects’ vision for togetherness,” adds Agneta. “They created opportunities for people to meet, talk, sit and eat together. Unlike individual tables and

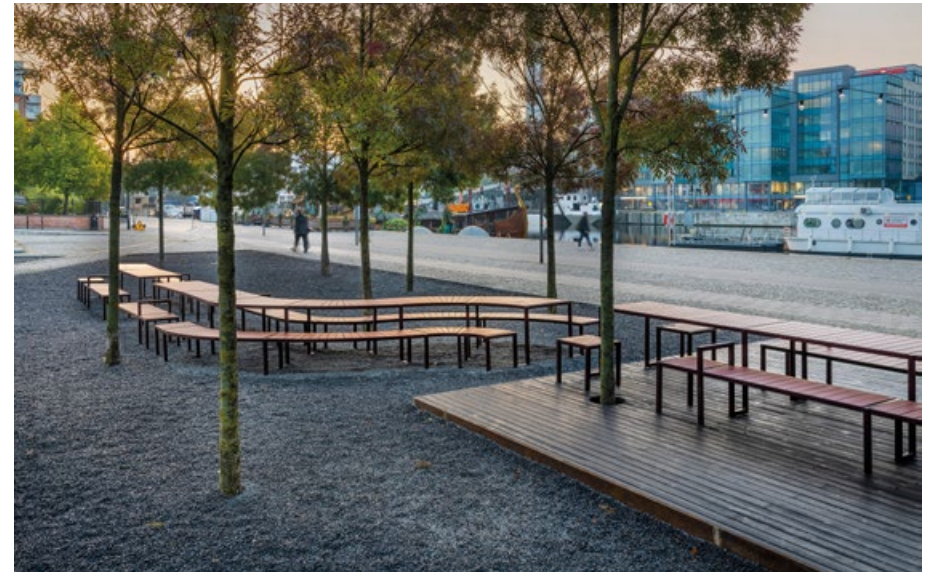

chairs or park benches, Långbordet provided a way to invite community members to socialise beyond imaginary borders.”

Although originally conceived as a temporary design, Långbordet lives on today, which is perhaps the ultimate proof of its success. The Långbordet community table concept is applicable to many places, especially where there is an ambition to change social dynamics. Not only does the concept bring people together, it makes it possible to activate dormant places.

That happened again recently when White Arkitekter installed a version of Långbordet outside their offices in Södermalm, a neighbourhood in the southern part of central Stockholm. The site had a history of being disregarded by locals, and subsequently became a gathering place for food trucks. Now that Långbordet has been installed there, it’s possible to sit down and enjoy a conversation with a friend or stranger when

eating your halloumi burger or taco-wrap. Like the very first Långbordet, this version is also made in an S-shape, putting an ‘S’ onto this south central neighbourhood too.

*Left:
Originally created for a site-specific project in Helsingborg. A version of the design was later installed at Hamntorget in Stockholm. Långbordet has now been included in Nola’s product range.*

*Above:
The project at Hamntorget was awarded Monocle Design Award for Best Public Furniture 2021.*

13

Products

Parco by Broberg & Ridderstråle
Långbordet by White Arkitekter
Four Seasons by Thomas Bernstrand
Kaskad by Björn Dahlström
Frank by David Taylor
Cacti by Anki Gneib
Sigill by Note Design Studio & Gunilla Allard
Kajen by Thomas Bernstrand
Revet by Bengt Isling
Korg by Thomas Bernstrand
Work Lounge by Charlotte Petersson Troije & Superlab
Elbin by Andreas Sture & Olle Anderson
Kebne by Kauppi & Kauppi

34

35



Parco
by *Broberg & Ridderstråle*

When space is tight, outdoor furniture solutions like Parco make room for more. The group consists of sleek seating and a streamlined table that are easy to cluster together, making them ideal for compact spaces. The chairs are designed with a swivel function and contouring seats and backrests that provide additional comfort. The products can be mixed and matched to create customised seating arrangements in a variety of indoor and outdoor settings.



Above:
Like the other designs in the furniture range, the park bench mounts directly to the ground to provide a permanent fixture in the landscape, public spaces or private courtyards.

Left:
Parco chairs in custom colour. The chairs can be ordered with or without arm rests.



Upper left:
Lounge chairs, tables and stools at Alviks Strand, Stockholm. The swivel lounge chair is a spacious design with an angled seat and backrest that encourages those seated to sit back and relax.

Lower left:
The Parco park bench is modern in style and generous in use. Available in several standard colors or in FSC-marked jatoba or Sioc-treated oak and is available with or without armrests.



Armchair
Height: 77 cm
Width: 56 cm
Depth: 52 cm



Chair w. Table Top
Height: 77 cm
Width: 53 cm
Depth: 53 cm



Child Seat
Height: 108 cm
Width: 30 cm
Depth: 30 cm

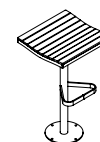

Bar Stool
Height: 80 cm
Width: 42 cm
Depth: 42 cm

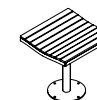

Stool
Height: 45 cm
Width: 42 cm
Depth: 42 cm

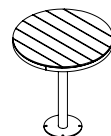

Round Table
Height: 72 cm
Diameter: 66/123 cm

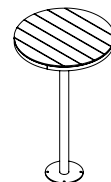

Bar Table
Height: 110 cm
Diameter: 66 cm

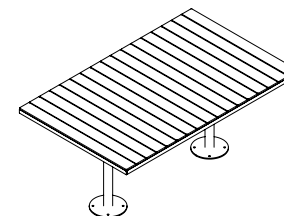

Conference Table
Height: 72 cm
Length: 161 cm
Width: 100 cm

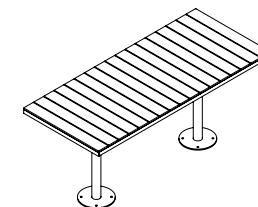

Rectangular Table
Height: 72 cm
Length: 161 cm
Width: 70 cm



Lounge Chair
Height: 97 cm
Width: 56 cm
Depth: 57 cm

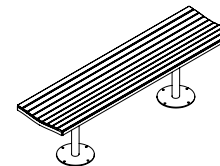

Bench
Height: 45 cm
Length: 161 cm
Depth: 42 cm

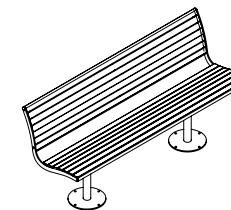

Park Bench
Height: 77 cm
Length: 161 cm
Depth: 51 cm



Långbordet

by *White Arkitekter*

Långbordet was created for connecting spaces and people. The table and seats adapt easily to different types of environments, where they can provide space for community meals, gatherings and youth activities. The system is expandable, able to follow pavement patterns, extend lengthways, arc into circles, or create curving shapes. The benches attach to the table at ground level, ensuring they remain in place at all times. The gaps between individual benches provide spaces for wheelchair users and access points for people of all ages and abilities.

40

Left:
Långbordet at Hamntorget in Stockholm. The project was awarded "Best Public Furniture 2021" at Monocle Design Awards.

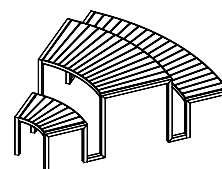

Curved Section
Height: 75 cm
Radius: 240 cm
Depth: 195 cm
Angle: 45°

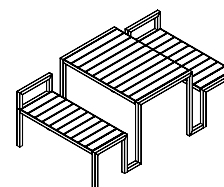

Section w. Benches
Height: 75 cm
Length: 100 cm
Width: 195 cm

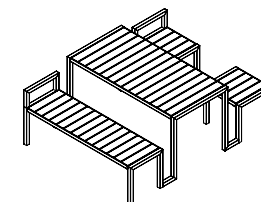

Section w. Bench and Stools
Height: 75 cm
Length: 140 cm
Width: 195 cm

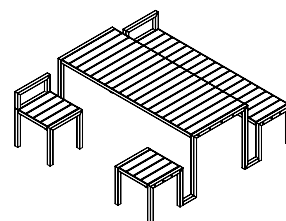

Section w. Bench and Stools
Height: 75 cm
Length: 180 cm
Width: 195 cm

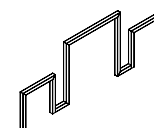

End Frame
Height: 75 cm
Length: 195 cm
Width: 4 cm

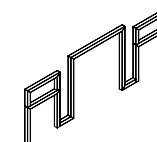

End Frame w. Armrests
Height: 75 cm
Length: 195 cm
Width: 4 cm

41



Four Seasons

by *Thomas Bernstrand*

The Four Seasons sun parasol is a sturdy year-round design that deflects the sun and provides shelter from the rain. Made from pieces of sheet steel circling around a steel post, the base bolts securely to the ground. Designed with a striking profile that tilts away from the base, this umbrella adds a contemporary element to city gardens, open courtyards or any environment where shelter and shade are needed.

42



Left:
*Four Seasons together with
LowBed from the furniture line
Low/High in Löga Skatepark in
Västerås, Sweden.*



All Year Parasol
Height: 255 cm
Diameter: 239 cm
Angle: 98°

43

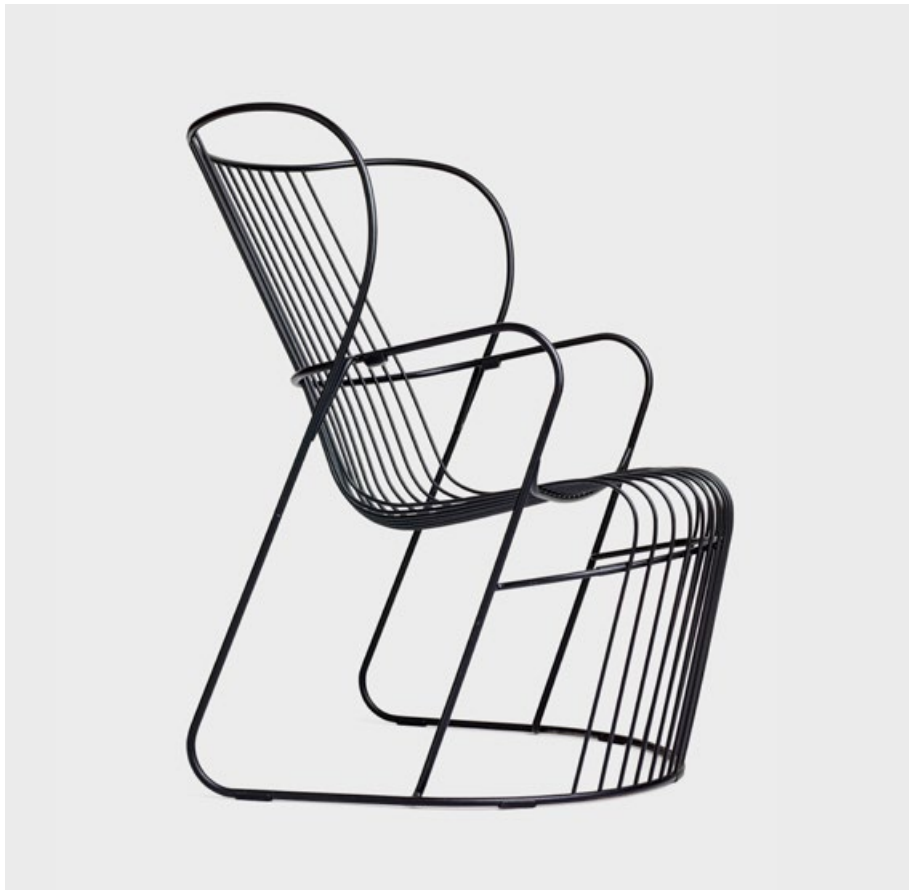

Kaskad

by *Björn Dahlström*

Inspired by fast-flowing water falling over rocks, Kaskad is crafted from ribbons of pliable steel curved over a contouring frame. Lightweight and comfortable, the chair flexes similarly to a sprung frame to add comfort. The Kaskad family includes an armchair, a side chair and a table. Their fluid forms and flowing lines resonate with contemporary architecture and make a stunning addition to café terraces, maritime areas and waterfront parks. Kaskad armchair received a Red Dot Design Award in 2013.



Chair
Height: 81 cm
Width: 63 cm
Depth: 58 cm



Armchair
Height: 88 cm
Width: 70 cm
Depth: 77.5 cm

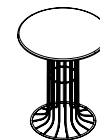

Table
Height: 71 cm
Diameter: 60 cm



Frank

by David Taylor

The Frank furniture group is strongly contemporary while able to complement traditional settings. Each of the three products is accessible and inclusive, offering higher seats and longer armrests that provide support for those less able. Crafted in recyclable sand-cast aluminium, Frank combines sustainability and style.



Above:
The Frank child's chair provides a uniquely inclusive design. Creating designated areas where parents and children can sit together in comfort.

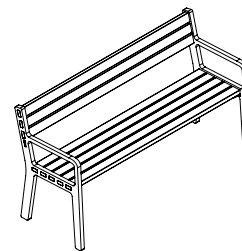

Bench
Height: 88 cm
Length: 160 cm
Width: 62 cm



Child's Chair
Height: 55 cm
Width: 32 cm
Depth: 35 cm



Armchair
Height: 88 cm
Width: 56 cm
Depth: 62 cm



Cacti

by *Anki Gneib*

These planters can refresh everyday environments with vivid colours and vibrant plants. Cacti are made with metal trellises that mimic the shapes and proportions of cacti. The planters bring nature indoors, adding decorative features or dividing space as they dampen noise and improve air quality. The planters are available in three different sizes with trellises made in three different heights.



Left:
The planters are inspired by the shape of the cactuses in artist Frida Kahlo's garden in Mexico.

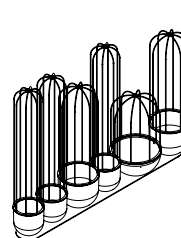

Group 1
Height: 171 cm
Width: 231 cm
Depth: 50 cm



Group 2
Height: 171 cm
Width: 101 cm
Depth: 80 cm

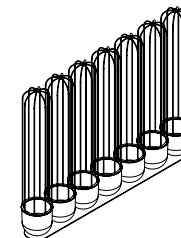

Group 3
Height: 171 cm
Width: 223 cm
Depth: 30 cm

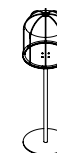

Bird Feeder
Height: 157 cm
Diameter: 41 cm



Hanging Basket
Height: 120/100/70 cm
Diameter: 30/40/50 cm



Hanging Basket Cocoon
Height: 132/81/66 cm
Diameter: 30/40/50 cm



Sigill

by *Note Design Studio*
& *Gunilla Allard*

Sigill is a park bench for the future that builds on the design styles of the past. The design is unique in its broken surface that angles two parts of the seat towards each other. The bench's contemporary shape gives it an urban context, making it ideal for sidewalks and parks. The ease with which Sigill can be moved, stacked and stored makes it a popular choice for summer terraces, outdoor concert venues and open-air services.

50

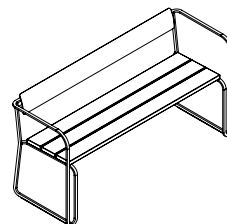

Park Bench
Height: 80 cm
Length: 156 cm
Width: 55 cm

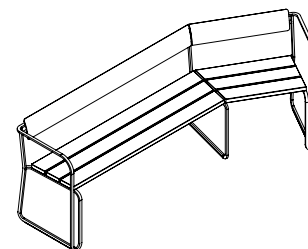

Park Bench in Angle
Height: 80 cm
Length: 226 cm
Width: 85 cm

51

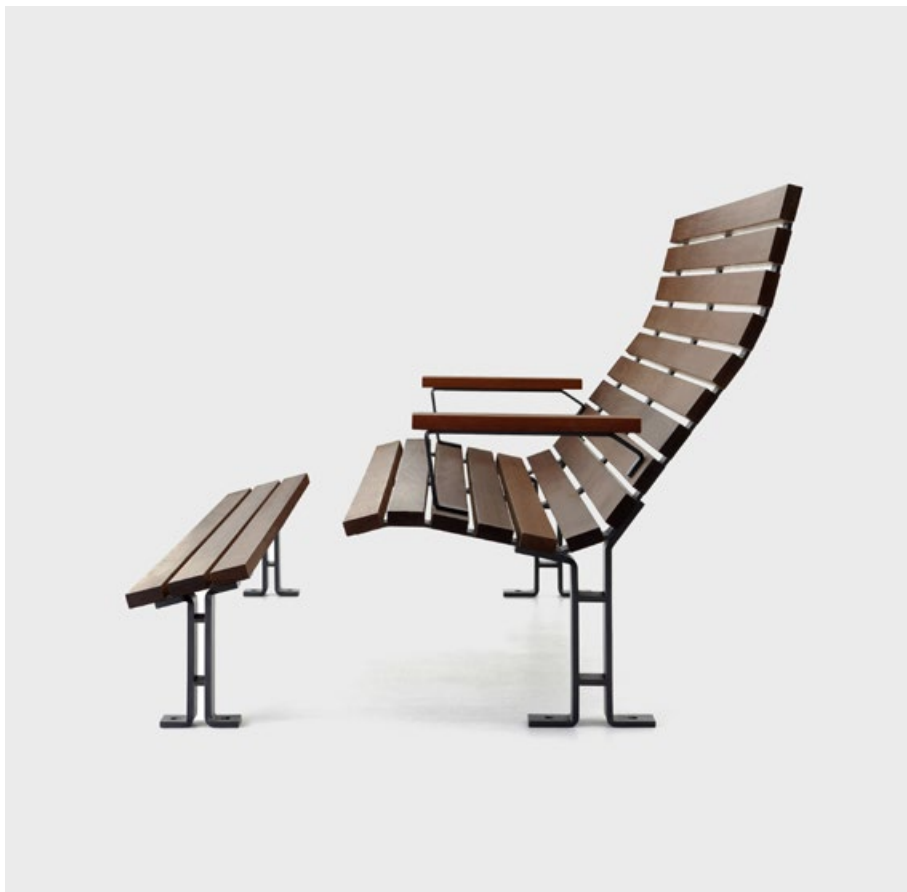

Kajen

by *Thomas Bernstrand*

Kajen is a popular choice for maritime and waterfront settings, yet the series enhances urban environments and public parks too. The chairs and benches are characterised by clean lines and comfortable seats that invite passers-by to sit down and relax. Kajen products can be ground-mounted, with many able to attach to upright surfaces and cantilever vertically over the ground. Kajen is uniquely customisable, offering a range of sizes and solutions to choose from.

52



Above:
Kajen is a versatile furniture range with its many shapes and sizes, creating truly unique spaces.



Left:
Kajen standing bench provides a perch that keeps individuals upright, enabling them to stand, straighten up and move on their feet. Reflecting the trend to work at stand-up desks and eat at chest-high tables, Kajen standing bench makes it possible to stand more, and sit less.

53



Left:
The Kajen series consists of a large variety of furniture options, surely one piece for every place.

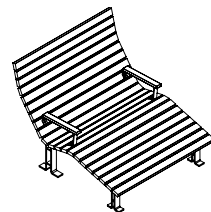

Sun Lounger
Height: 100 cm
Length: 120 cm
Depth: 130 cm

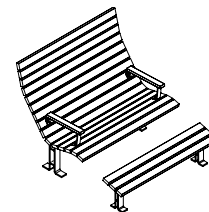

Sun Lounger w. Footrest
Height: 100 cm
Length: 120 cm
Depth: 130 cm

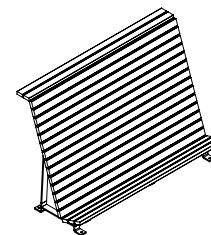

Standing Bench
Height: 122 cm
Length: 120/180/200 cm
Depth: 80 cm

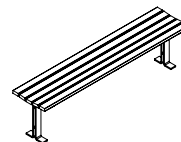

Bench
Height: 46 cm
Length: 180 cm
Depth: 40 cm

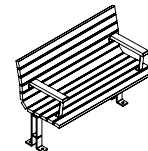

Park Bench
Height: 90 cm
Length: 120/130/300 cm
Depth: 55 cm

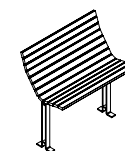

Mini Bench
Height: 88 cm
Length: 80 cm
Depth: 25 cm

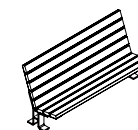

Low Park Bench
Height: 58 cm
Length: 120 cm
Depth: 41 cm

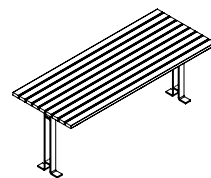

Table
Height: 72 cm
Length: 180 cm
Width: 74.5 cm



Rocking Chair
Height: 100 cm
Width: 73 cm
Depth: 78 cm



Revet

by *Bengt Isling*

The Revet bike shed is a purpose-built enclosure with plenty of room for bicycles. This easy-to-assemble prefabricated structure is built with a durable wooden roof that curves downward to create a wall. Several structures can be combined side-by-side to create a longer shed. Revet offers a value-for-money bike shed with the potential to be extended according to specific requirements. Revet can also provide shelter for baby prams and outdoor equipment.

56

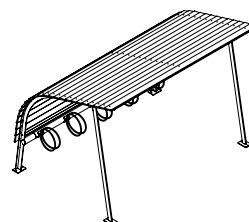

Bike Shed
Height: 200 cm
Width: 270/520 cm
Depth: 190 cm

57



Korg

by Thomas Bernstrand

Each design in the Korg family is formed by clean lines and soft contours. The group is comprised of armchairs and backed benches and includes a round café table. Korg's seats and backrests are made from robust steel thread, enabling rain and water to run off without leaving lasting marks. Each seat and table is attached to a sturdy cylindrical support that bolts securely to the ground. Modular versions of the seating designs are also available in the Korg furniture system.

Left:
Korg is a neat and expressive furniture range available both as individual products and as a modular furniture system.

Right:
The grid pattern of the wire seats creates a clear graphic expression.

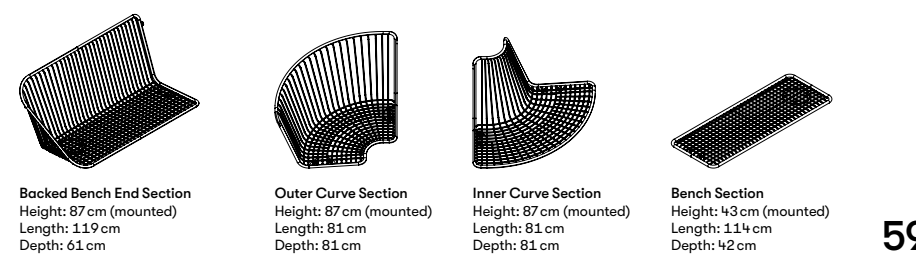
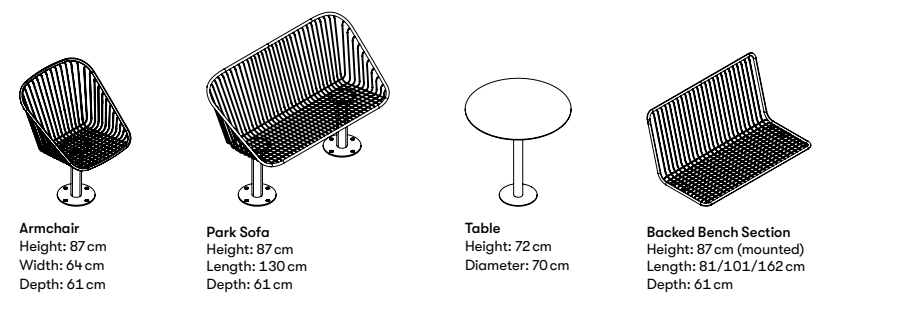
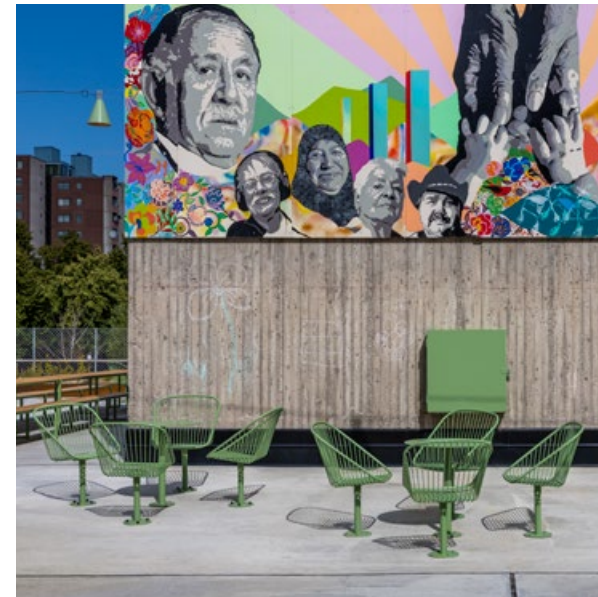



Work Lounge

by *Charlotte Petersson Troije*
& *Superlab*

Work Lounge makes a response to the rapid expansion of urban areas and the growing need for functional and practical outdoor workplaces. This individual workstation is crafted with a swivel seat made in soft foam for outdoor use and complemented by an adjustable table with space for a laptop. The high backrest divides space and creates a sense of privacy while enabling light to pass through.

60

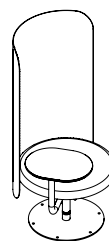

Swivel Chair w. Table Top
Height: 145 cm
Width: 91 cm
Depth: 69 cm

61



Elbin

by *Andreas Sture & Olle Anderson*

Elbin's wide opening makes it easy to place rubbish inside. It empties almost as easily; as the door unlocks and pivots open, the metal ring holding the waste bag slides outward to be emptied in one easy movement. The low height of the opening makes it more accessible to wheelchair users and children. Elbin can be wall-mounted or attached to the ground and ordered in three different sizes. A version with an integrated ashtray is also available.

62

*Left:
Elbin with an integrated
ashtray.*

*Right:
Elbin is designed to be easily
accessible with an opening
adjusted to children and
people with disabilities.*



Litterbin 501
Height: 90–94 cm
(depending on base)
Diameter: 41 cm



Litterbin 801
Height: 100–104 cm
(depending on base)
Diameter: 47 cm



Litterbin 1201
Height: 109 cm
Diameter: 55 cm

63



Kebne

by *Kauppi & Kauppi*

The Kebne outdoor gym consists of five free-standing fitness units for strength training and stretching. Inspired by a mountain landscape, the modules resemble minimalist sculptures. Each of the five modules is designed for exercises that use the individual's own body weight as a counterweight for resistance training, calisthenics and stretching. None of the modules contain levers, pulleys or moving parts of any kind, making them uniquely maintenance-free.

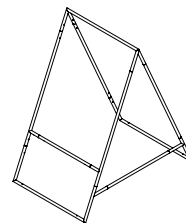

Modul 1
Height: 240 cm
Width: 210 cm
Depth: 140 cm

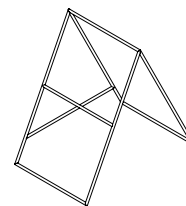

Modul 2
Height: 210 cm
Width: 210 cm
Depth: 140 cm

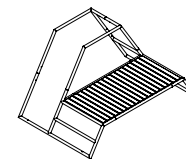

Modul 3
Height: 115 cm
Width: 210 cm
Depth: 140 cm

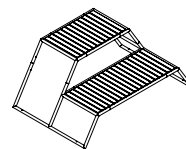

Modul 4
Height: 90 cm
Width: 210 cm
Depth: 140 cm

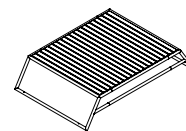

Modul 5
Height: 45 cm
Width: 210 cm
Depth: 140 cm

Always made in Sweden

Sustainability, Materials & the Environment

For us at Nola, sustainability is grounded in the ideas around how society and the cities of the future will function in symbiosis. Acting responsibly and being conscious about the decisions we make is fundamental to a sustainable future. We let design take its time so that what we make is properly consolidated into something that will be loved for as long as it lasts.

Sustainability means that our products must work and last for a long time, be easy to maintain and slot in with the ever-changing needs of society itself. We invest a lot of time, research and development into testing and evaluating our pieces before they end up on the market. When you select a Nola product you do so with the assurance that your choice will bring about a safe, creative, accessible outdoor environment.

There are a number of essential considerations we make to ensure Nola's range is

sustainable and unmatched in its quality. We strive to use non-toxic materials in our production and use manufacturing techniques that prioritise strength and resilience for safer public spaces that minimise environmental impact. We work constantly with eco-labelling and environmental standards such as FSC, *Byggarubedömningen*, *Svanens Husproduktportal* and *Sundahus*.

Production of Nola' products is solely based in Sweden, which means shortened delivery routes and the chance to constantly monitor that our logistics is in line with our own internal regulations. With regards to production we remain flexible and can to adapt to emerging innovation, techniques, processes and materials.



